

REPORT
Replace Report 02-771



October 29, 2002

Phone: +45 79 23 33 33
Fax: +45 75 56 44 77

Our ref.: JKG/HKP
Report no.: D- 158037
Project no.: 11746.01

Page 1 of 49

Verified: JKG Approved: HG

Elsam. Offshore Wind Farm. Horns Rev
Annual Status Report for the Environmental Monitoring Programme
1st January 2001 – 31st December 2001

Table of contents:

1.	Introduction.....	3
1.1	Description of the Wind Farm Project at Horns Rev	3
1.2	Access Conditions	6
1.3	Cables in the Wind Farm and to the Shore.....	7
1.4	Environmental Criteria and the Purpose of the Present Report for 2001	7
2.	Environmental Management.....	9
2.1	Environmental Management of the Wind Farm.....	9
2.2	Monitoring of the Environment.....	10
3.	Monitoring Programmes 2001	11
3.1	Bottom Flora and Fauna	12
3.1.1	Description of the Programme	12
3.1.2	Results of Monitoring 2001.....	17
3.1.3	Conclusions	21
3.2	Fish	21
3.2.1	Description of the Programme	21
3.2.2	Results of Monitoring 2001.....	24
3.2.3	Deviations from the Programme	25
3.2.4	Conclusions	26
3.3	Birds	26
3.3.1	Description of the Programme	27
3.3.2	Results of Monitoring 2001.....	29
3.3.3	Conclusions	31
3.4	Seals.....	33
3.4.1	Description of the Programme	33
3.4.2	Results of Monitoring 2001.....	34
3.5	Harbour Porpoises	34
3.5.1	Description of the Programme	35
3.5.2	Results of Monitoring 2001.....	40
3.5.3	Conclusions	43
4.	Conclusions.....	44
5.	Programme for the Environmental Surveys in the Area in 2002.....	46
5.1	Bottom Flora and Fauna	46
5.2	Fish	46
5.3	Seals.....	47
5.4	Harbour Porpoises	47
5.5	Birds	47
6.	References.....	49

1. Introduction

As a result of the Danish Government's Energy Plan 21 a target of 5,500 MW wind power is to be erected in Denmark by 2030. 4,000 MW of these are to be placed offshore in special pointed areas with minimal impacts on the environment.

In 1998 the Danish Ministry of Environment and Energy ordered two power companies, Elsam and Energi E2, to establish each a demonstration wind farm at one of the five pointed areas. The intention was to follow the environmental impacts from the wind farm and to evaluate the possibility of setting up about 1,500 MW in each area with as little impact on the environment as possible.

In 1999 the two power companies were given approval to begin pre-studies of each of the two wind farms and the work on the site construction as well as the environmental impact assessment related hereto was initiated. The authorities made a number of requirements for the EIA surveys according to the EU-directive for preparation of EIA reports.

In the summer of 2000 the EIA report with project description was submitted to the authorities and the project was approved in the spring of 2001. During the summer and autumn of 2001 orders were placed for the components for the wind farm, i.e. foundations, towers, wind turbines, cables etc.

After having finalised the EIA, monitoring programmes of the wind farms were initiated on basis of the results of the surveys carried out during the EIA. This means that continuous surveys have been implemented for most of the environmental parameters from 1999 and till today.

This annual status report for 2001 is to present the results from the annual environmental monitoring programme (the baseline studies) at Horns Rev, which form part of the monitoring programme set up for the Horns Rev project. To get a complete picture of the Danish monitoring programme for the national demonstration wind farm project it is necessary to see the report for Horns Rev and for Rødsand as a whole.

The report comprises a description of the wind farm project at Horns Rev, the environmental management system connected to the project, description and conclusion of each environmental monitoring project ending with a short description of the programme for the environmental surveys in the area in 2002.

1.1 Description of the Wind Farm Project at Horns Rev

The offshore wind farm consists of 80 wind turbines each of 2 MW placed in a grid pattern. The distance between the individual turbines and the lines is 560 m. The distance to the shore is about 14 km.



Fig. 1.1: Location of offshore wind farm and cable to shore.

The water depth in the farm area is between 6.5 and 13.5 m (MSL). The bottom consists of sand to about 20 meter.

The offshore wind farm consists of the following main components:

Foundations

The foundations are monopiles as shown in fig. 1.2.

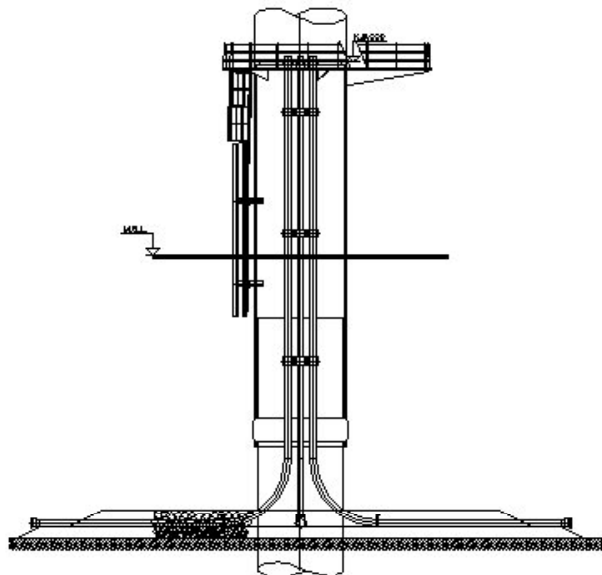

Fig. 1.2: Foundation.

The connection between the wind turbine and the foundation is placed 9 m above MSL. At this level, a small platform is placed.

Moreover, the foundation is equipped with a boat landing arrangement.

Monopile

The monopile consists of a steel pipe and a transition piece. The steel pipe has a diameter of 4 m and is rammed approx. 25 m into the seabed.

The purpose of the transition piece is to absorb tolerances on the inclination of the monopile and reduce the mounting operations required at sea as the major part of the equipment is mounted on the transition piece onshore.

Scour protection

When placing something at the seabed in an area affected by current and waves, the seabed around this object will erode. The monopile is, therefore, protected by placing stones of various sizes around the foundation in a diameter of about 25 m.

Wind turbines

The wind farm will comprise 80 similar wind turbines of the brand Vestas, type V80-2.0 MW, which are pitch-controlled up-wind turbines with 3 blades. The rotation direction is positive clock-wise seen from windward. The hub height is 70 m and the rotor diameter 80 m.

The maximum height to the top blade tip will be $70 + 80/2 = 110$ m. The main geometry of the wind turbines is illustrated in Fig. 1.3.

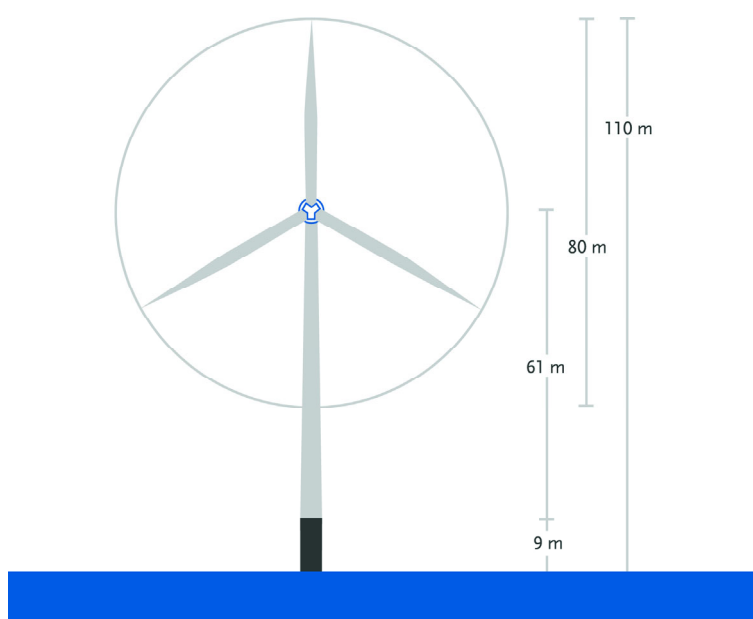

Fig. 1.3: Wind turbine dimensions.

The wind turbines are painted in a light marine grey colour (RAL 7035).

The main data for each wind turbine are:

Nominal power	2 MW
Power control	Pitch
Guaranteed noise impact (source noise)	107 dB(A)
Hub height (from top of foundation)	60.8 m
Rotor diameter	80 m
Minimum rotation figure	9.0 rpm
Nominal rotation figure	18.1 rpm
Maximum rotation figure	20.7 rpm
Weight:	
- Total rotor	37.2 tons
- Total nacelle (without rotor)	61.2 tons
- Tower	160 tons

Offshore-related changes have been made to the wind turbine as compared to a standard V80-2.0 MW wind turbine. Changes of importance to the environmental work are for instance:

- Surface treatment. The outside surface of the wind turbines are painted with a paint system fulfilling the requirements to a higher corrosion protection class than for onshore wind turbines. Inside, the turbines are equipped with a dehumidifier system in the tower and an air-condition system in the nacelle.
- Monitoring and remote control. Owing to the considerable costs related to service and maintenance, the scope of this has been extended. Further, the wind turbine's control system has been changed to meet the control requirements of the connection conditions.
- Sea marking with yellow lights.
- Air traffic marking of all exterior wind turbines with two middle intensive red flashing lights (2,000 cd +/-25 % with the possibility of reducing the intensity to 200 cd when visibility exceeds 5 km). The internal wind turbines will be marked with low intensive red lights of about 10 cd.
- Heli-hoist platform at the roof of the nacelle.

1.2 Access Conditions

The wind turbines can be accessed from boat as well as from helicopter. An access arrangement for boat landing will be placed at the south side of the foundations. The

access from sea will take place from a so-called MOB-boat (**Man-Over-Board** boat, which is a high-speed rubber dinghy) or from another suitable, small boat. The MOB-boat will be taken there by a larger service ship (mother ship).

The direct access to the wind turbines from a helicopter will take place by means of a so-called hoist operation. On top of each wind turbine will be a platform of approx. 4×4 m. A helicopter will hang in the air above the platform and staff and spare parts are then lowered down by means of a crane device - a hoist.

1.3 Cables in the Wind Farm and to the Shore

Cables (36 kV) in north-south direction will interconnect the wind turbines. All cables are connected to the substation as seen in the following figure.

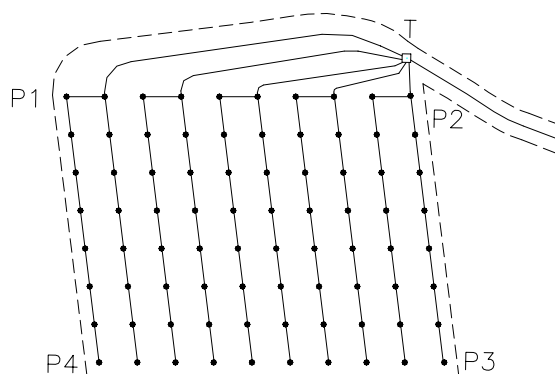

Fig. 1.4: Cable connection in the wind farm.

The submarine cable from the substation to the shore transfers the produced energy to Hvidbjerg Strand, where it is connected to the superior high voltage grid in Karlsgårde.

The cables are "three-core pex cables". These cables consist of three copper conductors, each surrounded by PEX insulation. Around the insulation is a lead casing and outermost, the cable is surrounded by a sea-armour to protect it from small anchors etc. The cables comprise a number of fibreoptic light guides for communication with the wind turbines.

1.4 Environmental Criteria and the Purpose of the Present Report for 2001

In the period from 1999-2000 environmental impact studies were carried out following the guidelines drawn up by the Danish Energy Agency and the National Forest and

Nature Agency. The background investigations for the EIA should be used to show no irretrievable damage on the environment. The investigations¹ indicated, that - owing to the very strong natural forces - the wind farm area is very robust and it is therefore not expected that the establishment and operation of the wind farm will have any essential impact on the area.

Based on the investigations, it was possible to set up a monitoring programme to assess whether the wind farm will cause measurable, temporary or permanent changes to the wind farm. It was moreover a demand in the approval of the project to evaluate the risks for changes in the area at Horns Rev regarding an extension of the project up to 1,500 MW, if possible.

The monitoring programme of Horns Rev has been set up in a co-operation with the authorities and is further to be seen in relation to the investigations of the project "Nysted Offshore Wind farm at Rødsand". The monitoring programmes are dynamic, so that they can be adjusted to the current situation.

¹ Havmøller Horns Rev. Vurdering af virkninger på miljøet. VVM-redegørelse. Maj 2000, Elsamprojekt 2000.

2. Environmental Management

In connection with the Danish Energy Agency's approval of the project it was a requirement to implement an environmental management system for the wind farm project. The environmental management system for the wind farm project comprises two separate systems:

- Environmental management of the wind farm.
- Monitoring of the environment.

2.1 Environmental Management of the Wind Farm

In connection with the preparation of various documents for the work at the wind farm, the preparation of the internal environmental management of the project was initiated. The environmental management system is among other things dealing with the environmental requirements specifically stated in connection with the authorities' approval of the project. Further, it deals with the project-related environmental requirements, which were for instance prepared in connection with the EIA report.

In general, the project's environmental management of the wind farm includes the following:

- Meeting of requirements and conditions stated in the authorities' approval of the project.
- Control of the project-related tasks.
- Control of operational tasks of the work at the wind farm.

Operation and maintenance of the wind farm is going to be a part of Elsams certificate ISO 14001. The environmental management of the project is included in a so-called HSE-plan (Health, Safety and Environment Plan) including handling/sorting of waste. The Project Handbook is in accordance with ISO 9001/14001 and there is a demand for all contractors to fulfil ISO 9001/14001.

As the environmental management of the wind farm does not form part of the reporting of the monitoring programmes, this subject will not be dealt with further.

2.2 Monitoring of the Environment

In connection with the approval of the project, requirements were made to implement various environmental tasks. In general, the projects environmental management includes the following:

- Control and implementation of monitoring programmes.
- Participation in various working and information groups.
- Reporting of the monitoring programmes.

The frames for control and implementation of the monitoring programmes have been worked out in a co-operation between the authorities, Elsam and E2. It has been decided that the monitoring programmes must be dynamic programmes to make it possible to make continuous adjustments. The aim is thus to have a close interaction between the programme at Horns Rev and Rødsand to utilise the experiences and for instance make effect studies at one wind farm and subsequently use the results hereof for a study at the other wind farm.

3. Monitoring Programmes 2001

The monitoring programmes are proposed by the Environment Committee of the Danish Offshore Wind Farm Demonstration Projects and carried out after final approval by the Danish Energy Agency.

For the two wind farms at Rødsand and Horns Rev the monitoring is concerned with birds, marine mammals (seals and harbour porpoises), fish, bottom flora and fauna, hydrography and geomorphology, magnetic and electric fields from cables, noise and vibrations and some theme projects concerning hard-bottom habitat and visual and socio-economic effect.

To secure as many results as possible seen from an environmental point of view it has been decided to try to focus on different issues at the two wind farm areas. At Horns Rev it has been decided to focus on harbour porpoises, birds and the two theme projects concerning the effect of introducing hard substrate habitat and the visual and socio-economic effect.

It is only relevant to study noise and vibrations during the construction and operation of the farms. At Horns Rev noise measurements will be performed during the construction and thus will only take place in 2002. Therefore, noise and vibration will not be described further or used as background information for specific research work. For hydrography and geomorphology at Horns Rev it is assessed that a basis description is sufficient, as the area is characterised by rough wave conditions implying that the sediment resettles very often, irregardless of the presence of a wind farm.

A baseline situation for seals will be described, but the monitoring is only taking place in 2002, why no results of the monitoring of seals are presented in this report. A short description of the work done in 2001 is presented in section 3.4.

For the bottom flora and fauna a baseline description will be made and there will also be monitoring of the situation after construction of the farm. But the main purpose of the monitoring of the bottom flora and fauna is to form basis for the monitoring of the effects of the introduction of hard substrate habitat. For more details about the monitoring programme and the results for 2001 see 3.1 and the status report for 2001².

Harbour porpoises will be monitored before, during and after the construction of the farm to be able to determine if the porpoises will be influenced by the operation of the farm and to what extent they will be affected by the construction. For more details about the results of the monitoring in 2001 please see section 3.5 and status report³.

² Horns Rev. Control and monitoring programme. Artificial reef. Progress memorandum 2. Bioconsult 21. January 2002.

³ Investigations of harbour porpoises at the planned site for wind turbines at Horns Rev. Status report 1/1 2001 – 1/4 2002. Technical report for Tech-wise A/S. Ornis Consult A/S, March 2002.

The effect on birds is divided into two parts: disturbance effect and risk of collision. At Horns Rev the main focus will be on the disturbance effect caused by the presence of the wind turbines. The assessment of the collision risk will only start up after construction of the farm, and is not described further. For more information about the monitoring programme and the results for birds please see section 3.3 and the status report⁴.

The theme project concerning a study of the effect of the introduction of hard substrate habitat will be based on the baseline descriptions for fish and bottom flora and fauna, and the first results of this study will not be available before 2003. In this report there is no description of the special programme for hard substrate habitat; only a description of the programmes and results of the monitoring of fish and bottom flora and fauna.

The last theme project: visual and socio-economic effect will be designed during 2002 and therefore no description or results of the programme are presented in this report.

The monitoring concerns the whole wind farm including both the turbines and the cables. But the programmes are designed to focus only on the relevant parts, so they only concern the cables where relevant.

3.1 Bottom Flora and Fauna

The expected impacts of the wind farm on the water quality and the benthic fauna in the area due to the farm are assessed in the Environmental Impact Assessment (EIA). As the changes to the current are only minor, impacts on the water chemistry and on the benthic fauna from hydrodynamic causes are expected to be limited or none at all. The suggestions in the EIA for subsequent measurement and monitoring programmes at Horns Rev did therefore not include water quality or the benthic fauna. After discussions it was, however, decided to monitor the benthic fauna in the area.

3.1.1 Description of the Programme

Prior to establishing the wind turbines, a baseline description of the benthic fauna (infauna) of the area will be carried out, as the basis for comparison with a subsequent monitoring programme. The baseline study will provide sufficient data to evaluate the effects on the composition of species and individuals of the benthic fauna as a result of the establishment of the foundations, in both the construction and operational phases. As the fauna in the area is limited it was accepted that the power of the study could be low. The study will also assist in evaluating the benthic fauna in the area as a food source for the area's fish species.

⁴ Status report of seabird surveys at Horns Rev, 2000 – 2001. NERI report 2002.

3.1.1.1 Objective of the Programme

The aim of the monitoring programme described below is to document possible changes in the composition of the species and individuals of the benthic fauna, and to follow the colonisation of the fouling communities on the foundations in order to evaluate the reef effect on other fauna of the area.

The programme for 2001 consists of a baseline description of the benthic fauna conditions in the wind farm area, and a description of the benthic fauna conditions in relation to the occurrence of potential food items for fish.

The principal hypotheses are:

- There is no spatial variation in the benthic fauna (infauna) between the proximate area and the impact area at any given depth;
- The foundations will have no hydrodynamic effect on the benthic faunal community.

3.1.1.2 Methods

The studies should be designed to meet the statistical requirements for testing the principle hypotheses to the fullest extent possible, however, taking temporal variations regarding the selected criteria into consideration.

Studies of the benthic fauna (infauna) are to be conducted on the basis of:

- Collection of quantitative samples to determine the species composition, abundance (density of individuals) and biomass using a Haps collector or divers;
- Video recordings of selected locations.

Criteria

The criteria for the impacts on flora and fauna have been established within closely defined zones.

The **proximity area** can be defined as the area physically occupied by the foundations and the area affected by water jetting when spooling the cables, as well as the area within 100 m of the construction site. Within this area, a reduction of biomass and species numbers of the benthic fauna and flora is acceptable. A radical change of habitat is generally acceptable, as a radical change in the benthic fauna from an infauna to an epifauna community is also acceptable. Along the line of the cable it is acceptable that

the vegetation and the benthic fauna are dredged up or covered, insofar as this does not cause the erosion of vegetation outside this area.

No specific criteria have been set for the distance limits of the **affected area** as the expected effects are minimal. The baseline and monitoring programme is very suited to make an evaluation of the overall changed as well as of the distance related effect.

In the **reference area**, at a distance of about more than 200 m from the construction site, conditions for the establishment and survival of the flora and fauna natural to the area must not be adversely affected.

Baseline Description

Field studies for the baseline description of the benthic fauna conditions in the wind farm area were carried out during the spring and summer of 2001 at 6 selected turbine locations. The 6 locations are in areas where the depth is less than 10 metres, and thus representative of the whole wind farm area.

The stations at the individual foundation locations followed a line in the direction of the main water current in the lee of the foundation as the expected impact will be due to the effect of possible changes in currents by the wind mill foundations. Thus defining a number of zones three stations in the direction of the main water current are to be selected at distances of 5, 25 and 100 m from the scour protection of the foundations. The distance of 5 m is within the affected area. 25 m is assumed placed at the border of the affected area. In 100 m distance no influence was expected, and by time the samples from 100 m can be used as reference samples from within the wind farm area. In this way the distance related effect on the bottom fauna could be studied.

Two Haps samples were taken at each station, with a sampling area of 0.0123 m². The samples were sieved through a mesh of 1 mm and the residues kept for subsequent analysis. All samples went through subsequent processing.

In addition, samples were collected at each station in order to determine grain size distribution via sedigradh analysis, and the content of dry matter and of organic matter in the sediment was determined.

The data from the benthic faunal study were analysed with multivariate statistical tools.

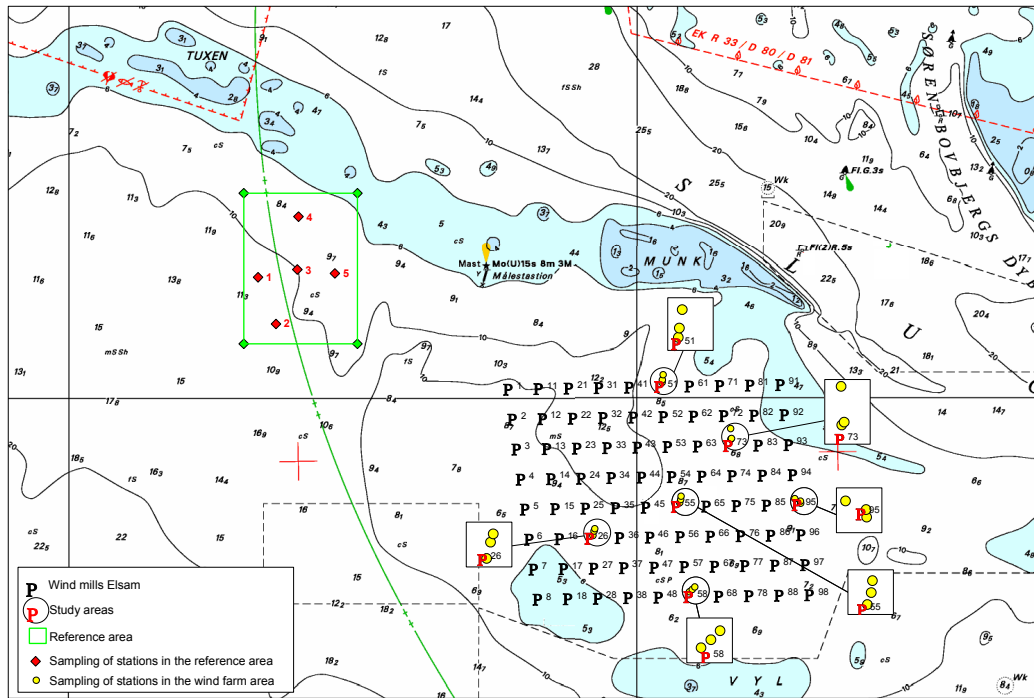

Fig. 3.1: Map of the studied localities, June 2001.

A video recording was made at each sampling station as documentation of the bottom conditions.

Food Items for Fish

The study of the benthic fauna conditions in relation to the occurrence of potential fish food items was carried out during the autumn of 2001 and was co-ordinated with the fish studies. These studies analysed the stomach contents of selected fish species to provide the baseline for evaluating fish food availability in the investigated areas. The stomach content studies were carried out as part of the fish studies programme.

At 3 of the 6 turbine locations used in the baseline description, benthic fauna and sediment samples were taken. The 3 locations are similar to the locations examined in the programme for fish. At each turbine location, samples were recovered from 3 stations along a transect, using the same positioning as for the baseline description study. The method for collecting and treating the samples was also identical with the baseline methodology.

In addition, sediment and benthic fauna samples were also collected at 5 stations in a designated reference area. The reference area is chosen as part of the fish studies programme, and is within the same depth interval as the wind farm area. The 5 stations are distributed over two different depth intervals that are representative of the reference area.

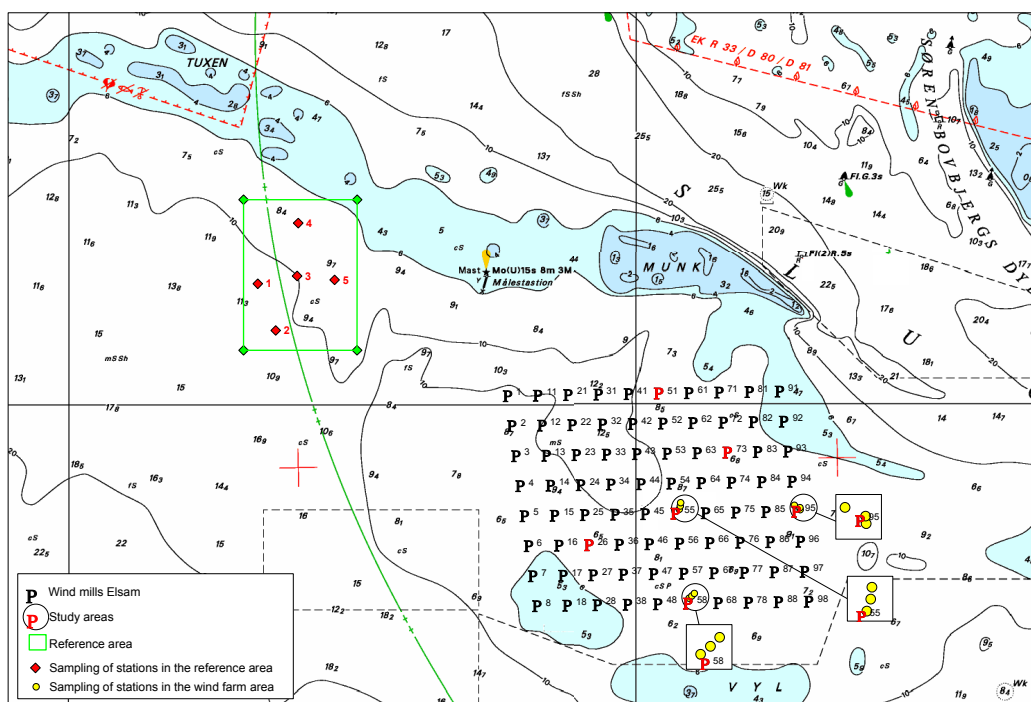

Fig. 3.2: Map of the studied localities, September 2001.

Coordinates for the reference area are given in WGS-84 coordinate system as:

"Corner ID"	"WGS84_MIN_Y"	"WGS84_MIN_X"
1	"55°30.500"	"07°43.000"
2	"55°32.000"	"07°43.000"
3	"55°32.000"	"07°45.000"
4	"55°30.500"	"07°45.000"

In accordance with the baseline description, video recordings were made at each sampling station as documentation of the bottom conditions.

Analysis and data manipulation methods follow exactly those used for the baseline description.

3.1.2 Results of Monitoring 2001

The wind farm area and the reference area are characterised by bottom conditions that are relatively uniform with a sediment consisting of pure medium-grained sand with no organic matter, which was also found in the surveys for the EIA. The particle sizes were found to be in the range of 228 μm to 426 μm with a median of 345 μm in the wind farm area. There is a tendency to more variation in the sediment structure in the reference area with generally more coarse-grained sediment with a median particle size of 380 μm (range 198 - 478 μm). In the deeper part of the reference area the seabed is characterised by more coarse-grained sediments.

Previous studies in the Horns Rev area have revealed that the main characteristics of the faunal composition in the area can be described as an *Ophelia borealis* community, named after one of the characteristic and important marine bristle worms in the area. The studies have also shown that the area is very heterogeneous with regard to the faunal composition and that the number of species, density of individuals and biomass of the benthic fauna can vary greatly within the area.

3.1.2.1 Study May – June

The number of species recorded at the individual stations in the wind farm area in May-June 2001 is rather uniform and varies between 5 - 12 whereas the abundance and the biomass varies from 488 - 2,033 individuals/ m^2 and from 2.9 - 489 g wet weight/ m^2 respectively, Fig. 3.3 - Fig. 3.4. There appears to be a tendency for a generally lower number of species, lower abundance and lower biomass in the eastern and northern part of the wind farm area.

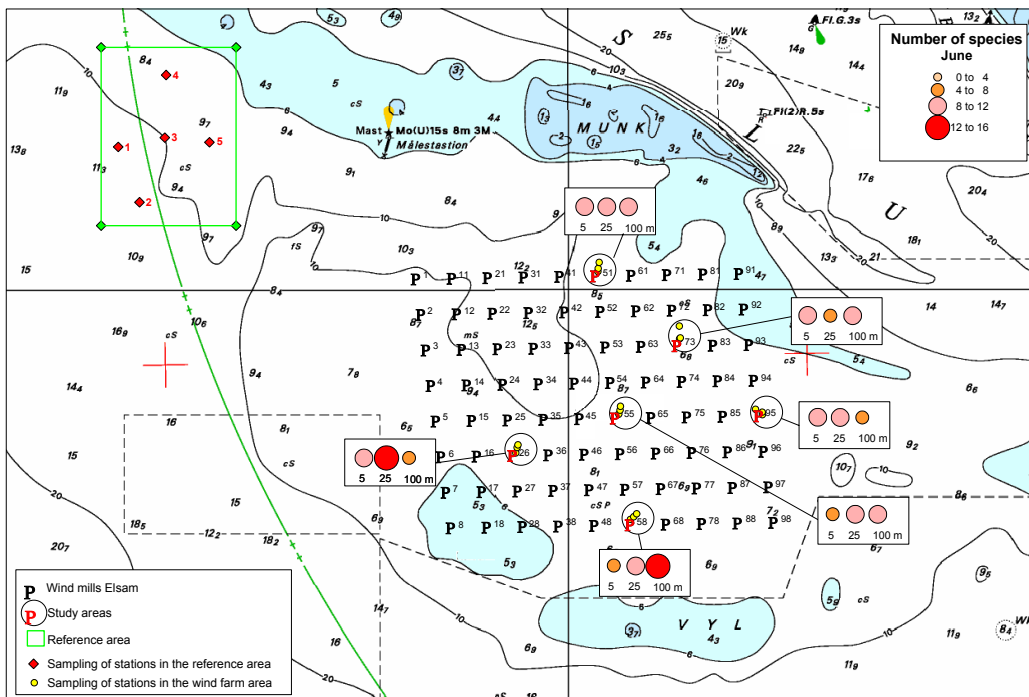

Fig. 3.3: Species numbers at the stations on Horns Rev, May-June 2001.

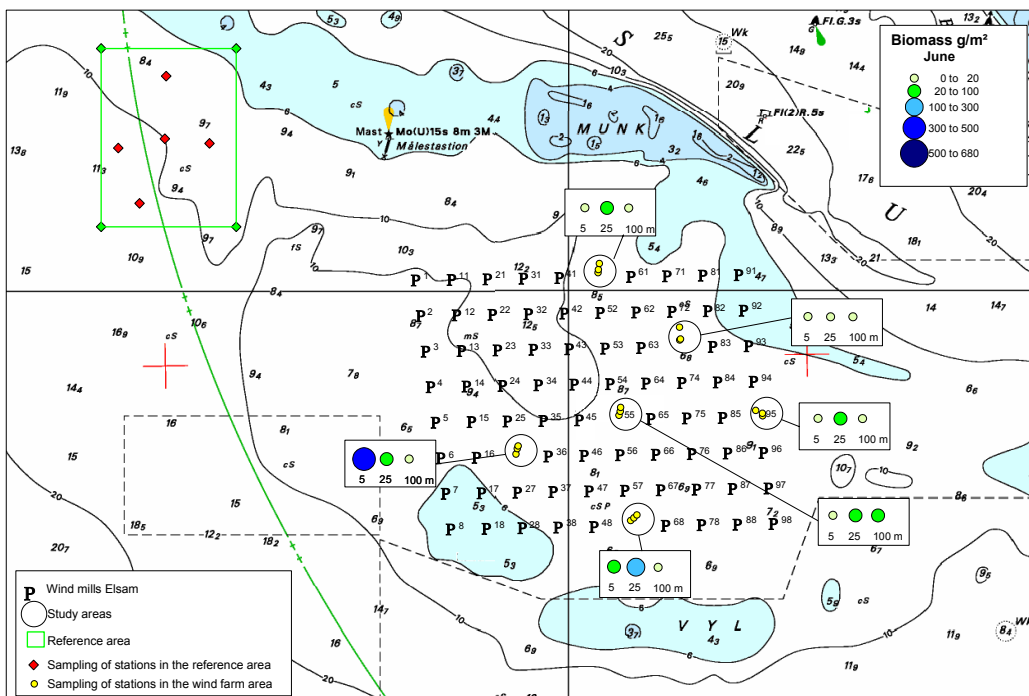

Fig. 3.4: Biomass (wet weight) at the stations on Horns Rev, May-June 2001.

3.1.2.2 Study September

The number of species recorded at the individual stations in the wind farm area in September is rather uniform and varies between 9 - 15 whereas the abundance and the biomass varies from 772 – 4,797 individuals/m² and from 2 - 436 g wet weight/m² respectively. There is apparently no generally tendency or difference in the distribution of the benthos in the area. However, the number of species is slightly higher and the abundance relatively high in the more deeper part of the reference area (14 - 16 species and 3,252 – 4,472 individuals/m²). The biomass in this area is generally low (6 - 19 g wet weight/m²) compared to the biomass in the wind farm area with the exception of reference station 3 at the slope to the deeper part, where a high number of *Spisula solida* contributes to a high biomass.

3.1.2.3 Description of the Benthic Community

The dominant species in terms of abundance in both the wind farm area and the reference area are the bristle worms *Pisone remota*, *Goniadella bobretzkii*, *Spio filicornis* and *Ophelia borealis* and the mussel *Goodallia triangularis*. These species constitute more than 58% of the total abundance.

The typical and dominant species in term of biomass in the wind farm area and in the reference area are the mussels *Spisula solida* and *Thracia phaseolina* and the bristle worm *Ophelia borealis*. These species constitute more than 84-95% of the total biomass in the areas.

Significant differences are recorded in terms of community structure between the wind farm area and the reference area, although the dominating species and the total abundance is almost identical at the two areas. Presumably, the two areas can be used for the comparison of the stomach content of different fish species in relation to the investigation of introduction of hard substrates as the dominant benthos species are recorded from both areas.

There seems to be a remarkably uniformity in the benthos community structure in respect of selected types of species between the surveys in 1999 and 2001, which indicate that these species can be used as indicator organisms for environmental changes. Although there are significant differences in abundance and biomass due to natural variations between surveys in spring/summer and autumn 2001 the results reveal a remarkable consistency in the relative dominance in respect of abundance and biomass between the indicator species, Table 3.1 - Table 3.2.

Species	2001	2001	1999	1999
	Abundance Ind./m ²	Relative abundance	Abundance Ind./m ²	Relative abundance
<i>Pisione remota</i>	176	19%	175	24 %
<i>Goodallia triangularis</i>	154	16%	167	23 %
<i>Goniadella bobretzkii</i>	129	14%	107	15 %
<i>Spio filicornis</i>	95	10%	7	1 %
<i>Thracia phaseolina</i>	59	6%	0	0 %
<i>Ophelia borealis</i>	47	5%	36	5 %
<i>Bathyporeia sp.</i>	38	4%	0	0 %
<i>Pontocrates altamarinus</i>	32	3%	1	< 0.5 %
<i>Spisula solida</i>	32	3%	6	< 1 %
<i>Orbinia sertulata</i>	25	3%	21	3 %

Table 3.1: The most frequently occurring species at Horns Rev in 1999 and 2001.

Species	2001	2001	1999	1999
	Biomass g./m ²	Relative biomass	Biomass g./m ²	Relative biomass
<i>Spisula solida</i>	42.109	65%	2.409	5 %
<i>Thracia phaseolina</i>	7.687	12%	0	0 %
<i>Ophelia borealis</i>	6.505	10%	8.948	20 %
<i>Orbinia sertulata</i>	2.788	4%	2.086	5 %
<i>Nephtys longosetosa</i>	2.338	3%	2.971	7 %
<i>Polinices polianus</i>	1.761	3%	0.043	< 0.5 %
<i>Nephtys sp.</i>	0.507	1%	0.011	< 0.5 %
<i>Goodallia triangularis</i>	0.400	1%	0.584	1 %
<i>Spio filicornis</i>	0.312	< 0.5%	0.058	< 0.5 %
<i>Gastrosaccus spinifer</i>	0.304	< 0.5%	0	0 %

Table 3.2: The most important species in terms of biomass wet weight at Horns Rev in 1999 and 2001

The selected indicator species (marked with bold text in the above tables) are the bristle worm *Pisione remota*, *Goniadella bobretzkii*, *Ophelia borealis*, *Orbinia sertulata* and *Nephtys longosetosa* and the mussel *Goodallia triangularis*.

No significant differences in the benthos community structure are recorded related to the distance from the planned foundations.

Compared to the survey in 1999 some species, like the mussels *Spisula solida* and *Thracia phaseolina* have a more pronounced abundance in 2001, whereas other mussels, like *Fabulina fabula* and *Angulus tenuis* recorded in 1999 were absent in the samples from 2001. Presumably, some small individuals of *Spisula solida* were recorded in 1999 as *Spisula elliptica* whereas *Thracia phaseolina* was not recorded in 1999.

3.1.3 Conclusions

Selected indicator species in the Horns Rev area seems to have a remarkable consistency in respect of relative abundance and relative biomass between different surveys, which might indicate that these species could be used as indicator organisms for environmental changes in relation to the establishment of wind turbines.

The baseline survey has also shown, that there is no prior difference in benthos community structure related to the distance from the planned foundations.

The study indicates that the reference area can be used for comparison of the stomach content of different fish species as the dominant benthos species are recorded in both areas.

The studies have shown that there are no significant differences in community structure, although there is a significant higher abundance and biomass in the autumn and between the surveys in spring/summer and autumn.

3.2 Fish

The conclusion from the environmental impact assessment is that the fish populations vary greatly from one year to the next. Based on this it was assessed to be inappropriate to monitor the fish population in general. But it was decided to follow the fish population regarding the introduction of hard substrate habitat (foundations) in the area.

3.2.1 Description of the Programme

3.2.1.1 Objective

The objectives of the monitoring programme are:

1. To study fish attraction relative to single foundations and to the wind farm;
2. To study the potential fish production enhancement of single foundations and of the wind farm.

3.2.1.2 Methods

The artificial reef impact on fish attraction and potential production from each wind turbine foundation, as well as the wind farm on a whole will be examined by studying the fish assemblages prior to and after construction of the wind turbines, from transects from individual wind turbines placed in different positions in the wind farm. The BACI

(before/after/control/impact) model was implemented involving fishing surveys in the wind farm area and in the reference area before and after the construction. Multi-meshed gillnets developed by the Danish Institute for Fisheries Research (KFG-12) are used as described below. Univariate and multivariate analyses will be conducted on the catch results to test the various hypotheses.

Reference area

In co-operation with the local fisheries organisations, the boundaries of the reference area were chosen. The criteria for the choice of reference area were that it should be:

- At a sufficient distance as not to be impacted by the wind farm;
- Same depth as in the wind farm area, or within the range;
- Similar fish assemblages as in the wind farm (from historical information from the fisheries organisations on the fishing patterns and type of fish or mussels fished in the two areas).

The position of the reference area is as follows in WGS-84 coordinate system:

55°31'0 N 07°43'0 E,
55°32'0 N 07°43'0 E,
55°31'0 N 07°44'0 E,
55°32'0 N 07°44'0 E.

The Gillnets

The multi-mesh gillnets called KFG are developed by DIFRES and consist of 12 gillnets of different mesh size ranging from 6.6 to 117 mm knot to knot (KFG-12). This gillnet was developed towards catching all sizes and types of marine fish in a coastal environment. Mesh-size and thread diameter are shown in Table 3.3.

Mesh no.	Mesh size (mm)	Thread diameter (mm)
1	6.5	0.09
2	8.5	0.09
3	11.0	0.09
4	14.3	0.12
5	18.6	0.14
6	24.2	0.15
7	31.4	0.17
8	40.9	0.20
9	53.1	0.24
10	69.0	0.28
11	89.8	0.34
12	116.7	0.40

Table 3.3: The knot to knot mesh size and thread diameter of the different mesh sizes constituting KFG-12 research gillnets.

Each mesh panel is 6 m long, mounted on a buoyancy line and lead line, with a hanging ratio of 0.3 (the hanging ratio defines how tightly or loosely the net is mounted and is important for determining the gillnet's efficiency for catching roundfish or flatfish). See Fig. 3.5 for a sketch of the gillnet. The mesh panels are randomly distributed in each KFG-12 with around 0.5 m space in between. The net is around 1.5 m in height. From the catches in the preliminary survey it was apparent that all mesh sizes should be maintained. Thus, each KFG-12 is around 80 m in total length.

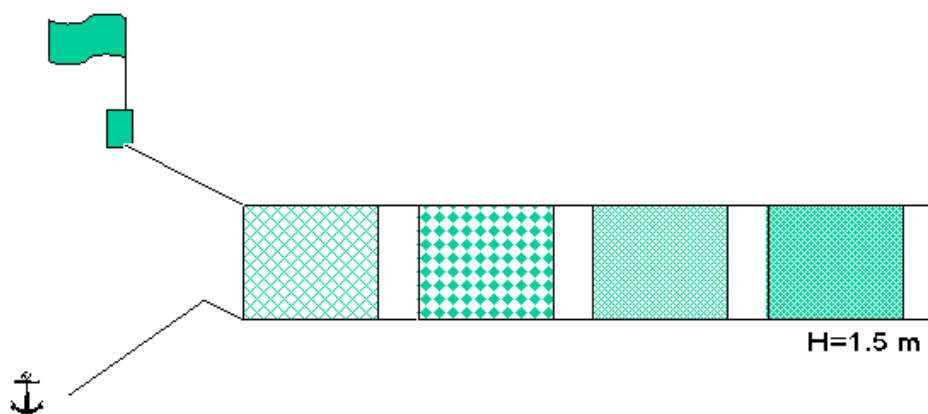

Fig. 3.5: A schematic drawing of the gillnet used in the monitoring programme showing four of the different sized mesh panels each 6 m in length.

The preliminary survey HR01-1 was conducted in August in the general area of Horns Rev, at six fishing stations each with one KFG-12 gillnet consisting of 12 mesh panels.

Survey

The first baseline survey HR01-2 was conducted during September. Each of three wind turbine positions (M55, M58 and M95) and the reference area were fished over 4 fishing days with six gillnets at each position. Because one fishing day was excluded from this study due to the turn of weather, M95 and the reference area were fished during 3 days. Table 3.4 gives an overview of the positions and total number of gillnets (= samples) fished during the survey.

Position	Gillnets deployed (samples)
M55	24
M58	24
M95	18
Reference	18
TOTAL	84

Table 3.4: Position and number of gillnets deployed at each position during the first baseline fishing survey (HR01-2).

3.2.2 Results of Monitoring 2001

3.2.2.1 The Preliminary Survey HR01-1

The catch results of the preliminary survey HR01-1 give a total of 186 fish distributed in 14 species caught in this preliminary survey. The most predominant fish species in the catches were whiting and plaice. On the basis of six gillnets (= samples) an average of 22.7 and 3.3 whiting and plaice were caught with a variability of 80% and 35% respectively.

3.2.2.2 The first Baseline Survey HR01-2

A total of 801 fish distributed in 21 species were caught in 84 gillnets during the first project survey. Since the wind turbines are not yet in place, the data from these three wind turbine positions are merged and compared to catches from the reference area.

The catch results of the first project survey HR01-2 constitute part of the baseline study. In general, a higher catch per unit effort (CPUE per KFG-12) of fish was obtained in the reference area as compared to the wind farm area. This is especially evident for whiting and dab and plaice, whereas a slightly higher CPUE for sand eel is observed in the wind farm.

A slightly higher number of species was caught in the wind farm area as compared to the reference area. This was due to singular or sporadic catches of species such as sprat, horse mackerel, dragonet, flounder, cat shark or sand goby.

Fish species diversity was not significantly different between the wind turbine and reference areas. This was tested using students' t-test and no significant differences were found.

A multivariate analysis was carried out on the data to test for similarity of fish assemblages in the wind farm area and the reference area. It shows a lack of distinct groups and implies no difference in fish assemblages between the two areas. Those samples closest to each other have the highest similarity, whereas those more distant have the lowest. There are no significant differences in fish assemblages between the wind farm area and the reference area in the late summer survey. On the other hand, the relatively high stress indicates few similarities between triplicate samples, which may give problems in later identifying possible differences between localities. This analysis needs to be repeated using the single data sets.

Despite efforts to minimise catches of crabs, their abundance is such that high catches are unavoidable. However, their presence in the gillnets was evaluated from visual appraisals of the gear and the condition of the catch, to have low impact on the catch efficiency of the gillnets. The crabs caught during the survey were identified to species and counted. The data are not included in the above univariate and multivariate analysis. Three species of crabs were caught: edible, swimming and shore crab. The occurrence of crabs in the two areas is similar except for that of the edible crabs, where significantly higher numbers were caught in the wind farm area as compared to the reference area.

3.2.3 Deviations from the Programme

The programme described above was changed compared with the original programme as agreed upon with Elsam. The changes are described below.

The **gillnets** have been modified and manufactured for this project. They were tested in a two-day preliminary survey at the area and the catches analysed. The results indicated that fishing with the modified KFG-gillnet is possible and that catches are relatively consistent. It was therefore decided to go ahead with the baseline study, although the following modifications had to be made to the survey design to accommodate the physical properties of the gillnets, the fishing conditions in the area and to ensure safety for the crew during fishing under these conditions.

- The number of stations at each of the three wind turbines has been reduced from four to three;
- The number of gillnets which can be deployed per day has been reduced from 20 to around 12;
- Fishery will not take place twice daily as planned, but only once daily and during a specific time period to encourage high catches of fish, and low catches of crab;

- The number of mesh sizes has been increased to 12 for each gillnet;
- Specific conditions for weather during fishery have been specified.

These adjustments are not expected to cause problems with regards to the data treatment.

3.2.4 Conclusions

The newly developed KFG research gillnets were tested in the Horns Rev area in a preliminary survey to examine their performance under these extreme conditions. The catches showed that it would be possible to complete the project since the variation in catches for particular fish species was within reasonable limits. However, the strong currents, exposed conditions and occurrence of huge numbers of crabs made it necessary to alter the original experimental field design to cater for these particular conditions.

The gillnets have proven to be practically the only type of gear, which can be used in this area. Trawling was out of the question because this would not be possible after the erection of the wind turbines due to the stones deployed around each foundation. Fish traps were also tried but the currents proved too strong for these and they were lost on the second day. The gillnets, on the other hand, have been shown to and continue to perform quite well. These gillnets are traditionally used for monitoring fish population size and structure in the freshwater environment, especially in lakes. They have been modified for use in coastal areas and are expectedly to be employed in routine monitoring of fish by several counties in Denmark.

The first project survey was conducted during September. All but one of the planned fishing days were performed within two fishing periods. The data are being computed in the fishery database at DIFRES. Due to time limitation, this analysis is based on spreadsheet data. The preliminary results show no significant differences between fish assemblages in the two areas, indicating the suitability of the reference area with this respect.

Univariate and multivariate analysis of the catch data from the wind farm area and the reference area show no differences between these two areas.

3.3 Birds

In the EIA it was concluded that there are high concentrations of resting and migratory birds in the area around Horns Rev and especially around Blåvandshuk. But to which extent these birds are affected by the wind farm is not clear, and therefore the monitoring programme for birds is set up.

The numbers and distributions of birds in the Horns Rev area are based on aerial counts carried out by NERI.

This part of the report presents the results of the 6 counts from 2001. This includes counts in February, March, April, August, September 2001 and in January 2002. The January count was originally planned for December, but due to poor weather conditions, the count was not carried out until January 2002. Data of aerial counts presented here include data from surveys performed from 1999 -2001, although some analyses are based on data collected during the full study period (1999 – 2002).

3.3.1 Description of the Programme

3.3.1.1 Objective

The objectives of the counts were to obtain data that enabled comparisons between the expected impact zone around the wind farm and a reference area, and to obtain data on which assessment of the relative importance of the entire area for birds can be made.

The main purposes of the counts were to:

1. Map the numbers and distributions of birds in the area throughout the year;
2. Assess the relative densities and numbers of different species present.

For a more detailed description of the scope for the bird studies and the methods used see the report "Effects on birds of an offshore wind park at Horns Rev" ⁵.

3.3.1.2 Method

Aerial Surveys

Mapping of bird distributions followed the method applied during the 1999-2000 surveys. Data on bird numbers and distribution were obtained from a total of nine aerial surveys during August 2000 to January 2002. The study area, approximately 1,700 km², comprises the wind farm area and the surrounding area, which is referred to as the reference area. See Fig. 3.6 for the study area with transect lines. Varying transect length is a result of temporary discontinuations of observations during periods of severe glare.

⁵ Effects on birds of an offshore wind farm at Horns Rev: Environmental impact assessment. NERI report 2000.

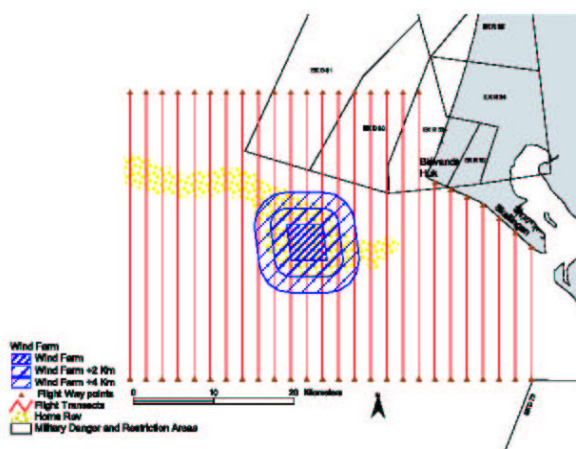

Fig. 3.6: The study area including transects (thin lines north-south) for aerial surveys.

Within-year and Between-year Variation in Bird Numbers

The degree of variation in the distribution of the different bird species, the seasonal (within-year) and year-to-year (between-year) variation recorded within the count data collected so far (August 1999 - January 2002) is analysed. The analysis is constrained by variation in the aerial coverage, with only the months August, September, February, March and April covered more than once. November was covered in 1999, October and December were covered in 2000 and January was covered in 2002. As to species with peak occurrence in the spring, the analyses is further constrained as the study has so far only been covering the spring period twice, while autumn data have been collected three times.

In analysing within-year and between-year variation, bird numbers have been corrected for variation in the distance covered by the aircraft during separate counts.

Distribution of Birds using the Horns Rev Area

The distribution of birds is presented as numbers of individuals recorded per transect kilometre covered within 2×2 km grid squares. These distributions also include data obtained during the period August 1999 to April 2000 and thus represent the overall distribution of all data collected on the different bird species.

Assessment of Potential Disturbance Effects

To quantify and assess the importance of the wind farm area to birds, 'Jacobs' selectivity index (D) (Jacobs 1974) was calculated to describe the birds' preference for the wind farm area compared to the surrounding reference area. The index (D), ranging from -1 (no birds in the wind farm area) to $+1$ (all birds in the wind farm area), can be tested by means of a one-sample χ^2 -test. The underlying assumption is that birds show a "geographically free" distribution, which means that the birds are equally distributed throughout the survey area ($D = 0$). Indexes were also calculated for the wind farm area plus an adjacent 2 and 4 km zone, respectively (see Fig. 3.6).

3.3.2 Results of Monitoring 2001

3.3.2.1 Bird Species recorded during August 2000 - January 2002

Species and numbers recorded during the nine aerial surveys are shown in Table 3.5. Bird species that are very difficult to separate during aerial surveys are grouped, while a few observations of migrating non-marine bird species (e.g. shorebirds) are omitted.

Bird species	21 Aug. 2000	6 Oct. 2000	22 Dec. 2000	9 Feb. 2001	20 Mar. 2001	21 Apr. 2001	22 Aug. 2001	26 Sep. 2001	7 Jan. 2002	Total
Fish-eating species										
Red-throated Diver (<i>Gavia stellata</i>)				9						9
Red-/Black-throated Diver (<i>Gavia stellata/arctica</i>)	6	23	38	192	149	87	2	3	54	554
Red-necked Grebe (<i>Podiceps griseigena</i>)	1									1
Fulmar (<i>Fulmarus glacialis</i>)	1	38			1			1	3	44
Gannet (<i>Sula bassanus</i>)	33	42			1	60	63	10		209
Cormorant (<i>Phalacrocorax carbo</i>)	80			1	20	2	25	32		160
Common/Arctic Tern (<i>Sterna paradisea/hirundo</i>)	175					40	843	4		1,062
Sandwich Tern (<i>Sterna sandvicensis</i>)	67					231	11	37		346
Guillemot (<i>Uria aalge</i>)	12	18			2	1	1			34
Razorbill (<i>Alca torda</i>)			1			1			5	7
Guillemot/Razorbill (<i>Uria aalge/Alca torda</i>)	48	162	35	32	14	8	16	36	104	455
Little Auk (<i>Alle alle</i>)		3								3
Red-breasted Merganser (<i>Mergus serrator</i>)					2	2				4
Arctic/Pomarine/Long-tailed Skua (<i>Stercorarius sp.</i>)	5						15	1		21
Little Gull (<i>Larus minutus</i>)			5	5	26	1		1	76	114
Black-headed Gull (<i>Larus ridibundus</i>)	164	1		3		253	69	13		503
Common Gull (<i>Larus canus</i>)	7	6	7	5	34	11	6	10	3	89
Lesser Black-backed Gull (<i>Larus fuscus</i>)	39	3				1	29	6		78
Herring Gull (<i>Larus argentatus</i>)	775	193	230	672	1,169	1,866	820	856	899	7,480
Great Black-backed Gull (<i>Larus marinus</i>)	55	24	2	5	3	56	96	59	27	327
Kittiwake (<i>Rissa tridactyla</i>)	579	35	17	30	14	108	183	251	142	1,359
Gull sp. (<i>Larus sp.</i>)	16	30	3			670		5		724
Benthic foraging species										
Eider (<i>Somateria mollissima</i>)	37	42	2,062	5,438	763	99	2	3	823	9,269
Common Scoter (<i>Melanitta nigra</i>)	283	2,208	8,436	11,041	13,295	16,902	319	4,661	30,483	87,628
Velvet Scoter (<i>Melanitta fusca</i>)		1	19	58	148	343	2	2	4	577

Table 3.5: Number of birds observed in the Horns Rev area during aerial surveys August 2000– January 2002. Results from 2001 are highlighted with bold text.

3.3.2.2 Disturbance Effects

In order to assess the magnitude of the potential disturbance effect on bird populations analyses of their exploitation of the proposed wind farm area and the adjacent areas were made in accordance with the methodology used in the previous investigation. These analyses included calculations of:

1. The percentage of birds within the wind farm area in relation to the number of birds in the total study area;
2. The percentage of birds within the wind farm area and an adjacent zone of 2 km in relation to the total number of birds in the study area;
3. The percentage of birds within the wind farm area and an adjacent zone of 4 km in relation to the total number of birds in the study area.

The adjacent 2 and 4 km zones are arbitrarily chosen and the latter (4 km zone) is considered as a 'worst case' scenario as the most conservative estimate of the area of potential habitat loss.

From calculation of the index (D) it was found that within the proposed wind farm area, no species occurred in proportions higher than expected when assuming a "geographical free" distribution in the study area. Most species showed a significant avoidance of the wind farm area (i.e. they occurred in lower numbers than expected). Divers and alcids occurred in numbers expected from a free distribution. Expanding the area with the adjacent 2-km zone provided a similar significant avoidance for all species, except divers, which again occurred in expected numbers. When the analyses included the adjacent 4-km zone, a significant avoidance was found in all species, except for Gannet and Velvet Scoter, which occurred in number expected from a free distribution.

The calculated number of birds per survey kilometre in the wind farm area compared to the number of birds per kilometre transect within the total reference area, gives an estimate of the relative importance of these areas to the different bird species. In these calculations, the ratios between the number of birds recorded in the wind farm area and the number of birds recorded in the reference area should be equal to 1.0 if there were no preference or avoidance to this area. If the ratio is higher than 1.0, then the wind farm area should be considered as more important than the rest of the reference area; on the other hand, if the ratio is lower than 1.0, the wind farm area should be considered as less important than the rest of the area.

Bird species	WP	D for WP+0	P	WP+2	D for WP+2	P	WP+4	D for WP+4	P	N
Fish-eating species										
Divers	1.58	-0.023	n.s.	4.88	-0.004	n.s.	7.51	-0.139	**	1,331
Gannet	0.00	-1.000	**	1.94	-0.446	**	9.51	-0.011	n.s.	515
Arctic/Common Tern ¹	0.87	-0.311	**	2.29	-0.377	***	5.28	-0.317	***	2,407
Sandwich Tern	0.00	-1.000	*	1.67	-0.506	**	3.34	-0.513	***	419
Guillemot/Razorbill	0.91	-0.294	n.s.	2.36	-0.364	***	7.79	-0.120	*	1,104
Herring Gull	0.06	-0.933	***	0.36	-0.868	***	1.74	-0.717	***	17,357
Great Black-backed Gull	0.00	-1.000	**	1.44	-0.560	***	4.32	-0.409	***	556
Kittiwake	0.71	-0.399	***	2.66	-0.309	***	6.63	-0.204	***	2,518
Gull sp.	0.00	-1.000	***	0.13	-0.949	***	0.54	-0.904	***	744
Benthic foraging species										
Eider	0.01	-0.990	***	0.01	-0.997	***	0.01	-0.998	***	12,355
Common Scoter	0.43	-0.588	***	2.44	-0.348	***	8.15	-0.095	***	128,614
Velvet Scoter	0.00	-1.000	**	0.00	-1.000	***	8.05	-0.102	n.s.	621
Size of the area to the total area (% of transect km)	1.65			4.92			9.70			

¹including observations of 'terns sp.'

Table 3.6: The percentage of the total number of individuals recorded (August 1999-January 2002) in the proposed wind farm area (WP), in the wind farm area and an adjacent 2 km zone (WP+2) and in the wind farm area and an adjacent 4 km zone (WP+4) respectively. The size of the area is expressed as the percentage of transect kilometers counted within each area as a proportion of the total number of transect kilometers counted within the total study area. The 'Jacobs' selectivity index (D) is given; negative values indicate that the species avoid the area in question, positive values that the species show preference for the area. N is the total number of individuals of the different bird species observed during the 16 aerial counts. P is probability values for χ^2 one-sample test to compare values (WP column) with the values expected from a "geographical free" distribution (: $P < 0.05$; **: $P < 0.01$; ***: $P < 0.001$; n.s.: non significant).*

3.3.3 Conclusions

3.3.3.1 Within-year and Between-year Variation in Bird Numbers

In order to make as precise assessments as possible of the potential impacts on birds from operating offshore wind farms, knowledge of the within-year and between-year variation in bird numbers is essential, both within the wind farm area as well as in the adjacent areas.

As the study period so far only comprises two and a half years, it is difficult to assess whether the observed year-to-year variation in the abundance and the distribution of the species represents 'normal variation in the Horns Rev area. In general, bird numbers of

both migrating and wintering species may show large within-year and between-year fluctuations in abundance as well as in distribution. These variations may be related to factors such as reproductive success in the preceding breeding season, timing, duration and severity of winter, timing of spring, and availability of food resources.

The within-year variation in the occurrence of the bird species in the Horns Rev area closely correlate to the phenology of these species recorded at Blåvandshuk. Thus, the present investigation did not find any deviation in the seasonal occurrence of the recorded species from what was expected.

The year-to-year variation in the abundance of the birds in the Horns Rev area was generally found in species that migrate through the area, e.g., terns, Gannets and Kittiwakes, while less pronounced variation was found in staging and wintering species, e.g. divers, Herring Gulls and Common Scoters. Of the migrating species, both Arctic/Common Tern and Sandwich Tern have distinct migration periods (March-May and July-August) and the timing and intensity of migration in these species may vary in relation to the weather conditions. Gannets have a short intense migration period in autumn (September), and the recorded year-to-year variation in maximum occurrence of this species probably relates more to the difference in the timing of the counts during this period than to any real differences in abundance between years. Of the wintering species, only the Eider showed pronounced between-year variation in abundance in February. As previously mentioned, the occurrence of very high numbers of scoters in January 2002 is probably related to a period of cold weather during late December that have moved birds from the inner Danish waters to the North Sea.

3.3.3.2 Seabirds' Use of the Horns Rev Area

From the spatial distributions of birds obtained during the full study periods (pooled data August 1999-January 2002), the following conclusions were made.

Species foraging on fish (including gulls) were generally distributed in the offshore parts (more than approx. 2 km from the coast) of the study area. The occurrence of these species was variable and all showed a more or less scattered distribution in the study area. During some counts, the highest numbers of, for example, Gannets, alcids and Kittiwakes, were observed north of Horns Rev, in other counts the highest numbers were observed south of the Horns Rev. No species were found in high numbers on the shallow parts of Horns Rev (i.e. within the proposed wind farm area, see table 3.6).

Of species foraging on sessile benthic fauna (Eider and Common Scoter), only small numbers were observed at Horns Rev. The general distribution of these species is more coastal. In most cases the species were observed close to Blåvandshuk and Skallingen, although a relatively high number of Common Scoters were found exploiting the area southeast of Horns Rev in April 2001.

Based on the data and calculations obtained during the full study period, August 1999-January 2002, a general tendency for lower than expected numbers within the wind farm area was found. Thus, it can be concluded that:

1. No data collected so far indicate that the wind farm area is of any particular importance to the birds exploitation of the Horns Rev area;
2. If the birds avoid exploiting the wind farm area, this will affect a maximum of 1 % of the study area;
3. If the birds avoid the wind farm area the impact is estimated to affect less than 1% of the different species except divers where 1.58 % may be affected;
4. Even if a very conservative 'worst possible case' scenario is assumed, with birds totally avoiding the wind farm area and the adjacent 4 km zone the impact is estimated to affect approx. 8(-11) % of the Common Scoters, approx. 10 % of the Gannets, 7-9 % of the divers, alcids and Velvet Scoters, while the corresponding proportions of the remaining species will range between 0-6 %.

With the possible exception of Common Scoter, which showed some variability in numbers and distribution, the data collected so far indicate that the bird distributions are relatively consistent when considering both the within-year and the between-year variation in abundance and distribution of the different species.

3.4 Seals

In the EIA only few seals were observed in the wind farm area and therefore, it is not expected that the wind farm area would be of any interest to the seals.

As part of a joint project between the Netherlands, Germany and Denmark concerning the occurrence of the common seal in the international Wadden Sea, the Fisheries and Maritime Museum in Esbjerg marked 40 seals with VHF radio transmitters during 1990-1995. The studies accomplished in this connection showed that the seals made forage expeditions to the North Sea, but owing to the limited transmission distance of the VHF transmitters it could only be demonstrated that the seals from the Wadden Sea passed north towards the area of Horns Rev, where contact to the transmitters was lost.

3.4.1 Description of the Programme

The monitoring of the seals consists of a baseline study of the seals in the area. Based on the results of this study it will be possible to analyse the seals' use of the area.

3.4.1.1 Objective

The monitoring programme has been set up with the purpose of:

- Mapping the common seal's use of the area of Horns Rev;
- Studying the seals' forage strategies accordingly.

3.4.1.2 Baseline Investigation

Ten seals will be provided with a satellite transmitter, type SDR-ST16, Wildlife Computers. Further to registration of time and position, these transmitters register time-depth, which will provide information on the seals' diving behaviour and possible forage.

The time schedule set for the project includes an observation period during the first six months of 2002.

The monitoring programme was accepted on November 8, 2001 and the transmitters were delivered in December 2001, so the first seals were marked just after New Year - on January 4, 2002 - when four common seals were provided with transmitters. During spring 2002 all ten seals have been marked.

The studies are accomplished in a close co-operation with the Danish National Environmental Research Institute, AM, who are in charge of a similar project for SEAS at Rødsand.

Further, the co-operation includes University of Southern Denmark in Odense, where a student working on an extended essay has been connected to the project.

3.4.2 Results of Monitoring 2001

There are no results from 2001, as the programme was only designed and agreed upon in the autumn 2001.

3.5 Harbour Porpoises

On the basis of two years of ship-based surveys and analyses of historic data, the impact assessment regarding harbour porpoises for the Horns Rev wind farm was finalised in February 2000. The results of the impact assessment suggested that short-term effects on harbour porpoises would take place as a result of disturbance during the construction phase caused by a large number of service boats and sound emissions from the ramming

activities^{6 7}. The EIA estimated that the animals would disappear from the wind farm area during construction, and subsequently return to the area after the construction activities have ceased.

Following the EIA, a monitoring programme was launched to measure the level of long-term effects on harbour porpoises at Horns Rev, and baseline investigations have been carried out until today, - at the onset of the construction phase.

3.5.1 Description of the Programme

3.5.1.1 Objective

The programme has been designed in relation to the following hypotheses:

1. During the construction phase, a major impact on harbour porpoises is expected in the wind farm area. The ratio of density and acoustic activity of harbour porpoises in the impact area to the reference areas will presumably decrease;
2. During the operational phase following construction of the wind turbines, harbour porpoises will return to the wind farm area. Compared to the baseline, the change in the ratio of density and acoustic activity of harbour porpoises in the impact area to the reference areas will not exceed 25 %.

3.5.1.2 Method

During 2001 new acoustic methods and hydrographic monitoring supplemented the visual surveys. Stationary acoustic data-loggers (so-called T-PODs, porpoise click detectors) were applied and the use of the T-POD as a means to collect acoustic survey data was also tested during the period.

The T-POD is recording click sounds from harbour porpoises of short duration. It is programmable and can be set to specifically record echolocation signals that harbour porpoises use for orientation and foraging. This method will potentially provide data on harbour porpoise activity on a smaller geographic and longer time scale (diurnal and year-round) than surveys, thus being an important supplement or a potential compliment to surveys.

⁶ Environmental impact assessment. Investigation of marine mammals in relation to the establishment of a marine wind farm at Horns Rev. Fisheries and Maritime Museum, Esbjerg, Ornis Consult A/S and Zoological 'Museum, University of Copenhagen, 2000.

⁷ Havmøller Horns Rev. Vurdering af virkninger på miljøet. VVM-redegørelse. Maj 2000, Elsamprojekt 2000.

The presence of harbour porpoises at Horns Rev is largely believed to be governed by large-scale hydrographic features such as water masses. The baseline investigations have documented that in order to be able to detect the potential impact of an offshore wind farm on harbour porpoises in this hydrographically strongly structured region of the North Sea it is essential to monitor the distribution of water masses. Consequently, a hydrographic monitoring programme has been applied, which ensures that the water mass can be determined for all acoustic and visual recordings of harbour porpoises.

Hence, in order to increase the statistical power of harbour porpoise data collected by the stationary T-PODs, two CTD-stations (measures salinity and temperature) were launched during 2001.

3.5.1.3 Monitoring Design and Statistics

The EIA study recommended the statistical method BACI for detection of long-term effects of the presence of the Horns Rev wind farm on the number of harbour porpoises in and near the wind farm area. Accordingly, a monitoring programme has been set up with the aim to estimate the level of harbour porpoise abundance before and after the construction phase in 2002, and in particular to compare changes in the reference area with the changes in the wind farm area.

Impact and Reference areas

The changes in the abundance of harbour porpoises at Horns Rev are compared between the wind farm area and three reference areas; one east of the wind farm and two west of the wind farm, see Fig. 3.7. This design has been chosen, as all three reference areas lie within the hydrographic region, which forms the frontal gradient between the core estuarine water mass close to the coast and the more saline water masses of the North Sea. This frontal region has been identified as holding higher densities of harbour porpoises at all times of the year than the core of the estuarine and the North Sea water masses (see hydrographic results for more details). As all four areas form part of the Horns Rev structure, they share both topographical and hydrographic characteristics, and the abundance of animals is expected to be sufficiently high in all areas to generate relatively large data sets. The location of reference areas on the central and western part of the reef also ensures that data collected during the monitoring programme can be used as a basis for assessment of impacts on harbour porpoises from a possible future enlargement of the Horns Rev wind farm.

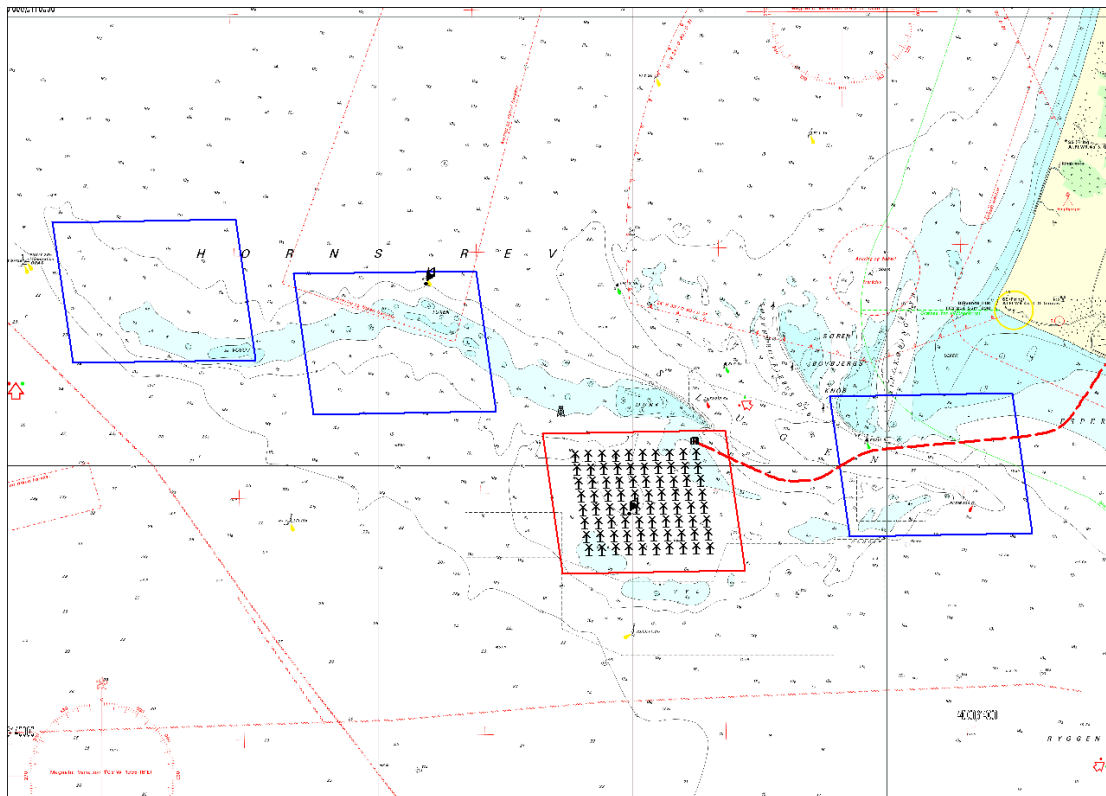

Fig. 3.7: The location of the Horns Rev wind farm area (impact area, red square) and reference areas (blue squares) and the power connection to shore.

Deployment of T-PODs

Eight positions at Horns Rev were chosen for deploying T-PODs (two in the impact area and two in each of the reference areas, see Fig. 3.8). The positions are numbered from 1-8 starting from west. Position 5 and 6 are in the wind farm area, and the rest are in the three reference areas.

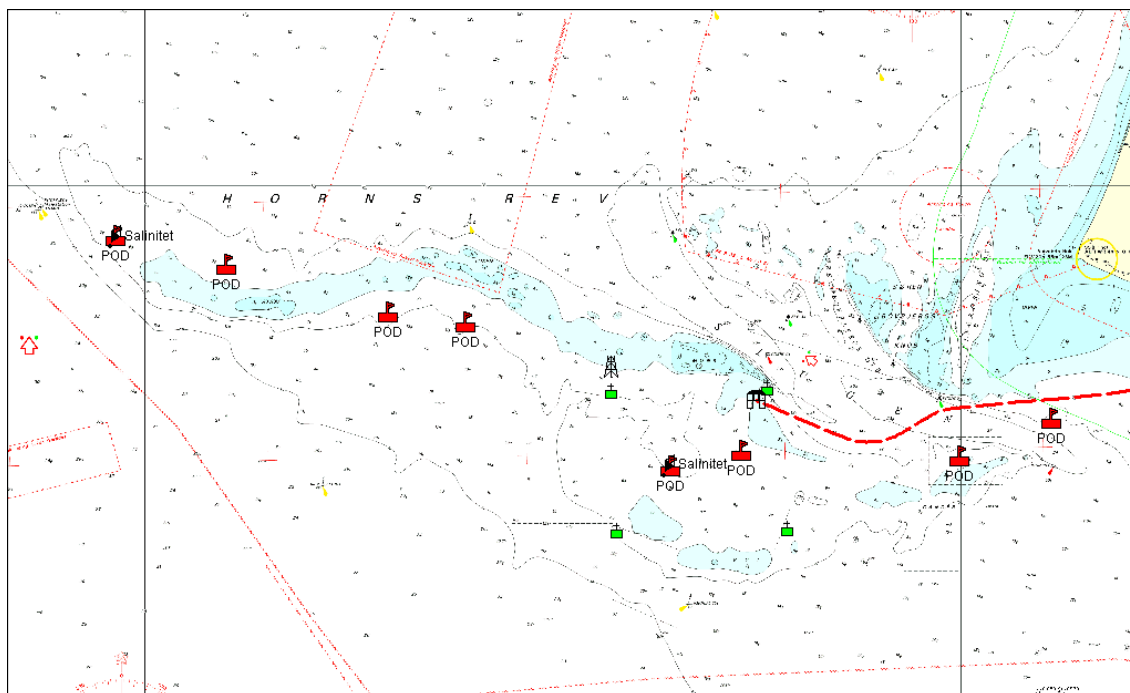

Fig. 3.8: Location and number of the eight stationary T-PODs (red flags) and DTDs.

The first T-PODs were deployed at Horns Rev in July 2001. Data from the T-PODs have been collected up to January 2002. Data from T-PODs 2, 4 and 7 were not used in the following as data from these only covered few days. The active logging time for each T-POD has not been more than 20-30 percent of the actual deployment time. This is mainly due to two things:

- First, it has not been possible for the service personnel to do all the necessary maintenance visits due to bad weather and an excessive effort to retrieve lost gear. The result is that T-PODs have been left for 3-4 months without maintenance instead of every two months, which is the lifetime of the batteries.
- Second, the set-up of the software in the T-POD was originally tuned in to operate in the inner Danish waters, but it has proven inefficient at Horns Rev due to the noise level from waves and shipping noise.

Hydrographic Monitoring

For monitoring the hydrographic variability, two CTD stations were deployed at T-POD no. 1 and 5 by mooring them in the same way as the T-POD. The CTDs were launched on October 15, 2001. Both CTDs were set to measure temperature and salinity at 10-minute intervals. The CTD at T-POD 1 was lost during the first deployment and could not be retrieved, as the buoy had disappeared. But data from the CTD at T-POD 5 have been downloaded once in 2001.

Visual/Acoustic Surveys

Ship-based surveys are an important component of the monitoring programme, as they can measure changes in the distribution of animals over distances much larger than the detection radius of stationary T-PODs, which is 2-300 m.

Relative densities of harbour porpoises were sampled along 15 east-west transect lines (see Fig. 3.9). A relatively high resolution of the data was achieved by dividing each transect into segments of 2 time minutes (approx. equivalent to 500 m transect distance). Each segment constituted a sample of relative density. The distance between lines was one km, except for the northern-most and southern-most lines, which lie 2 km from the nearest lines. The placement of survey lines was controlled by the dominant large-scale gradient in hydrography. In addition to the estimation of fine-scale distribution patterns the surveys are also used to produce estimates of the relative abundance of harbour porpoises in the surveyed area.

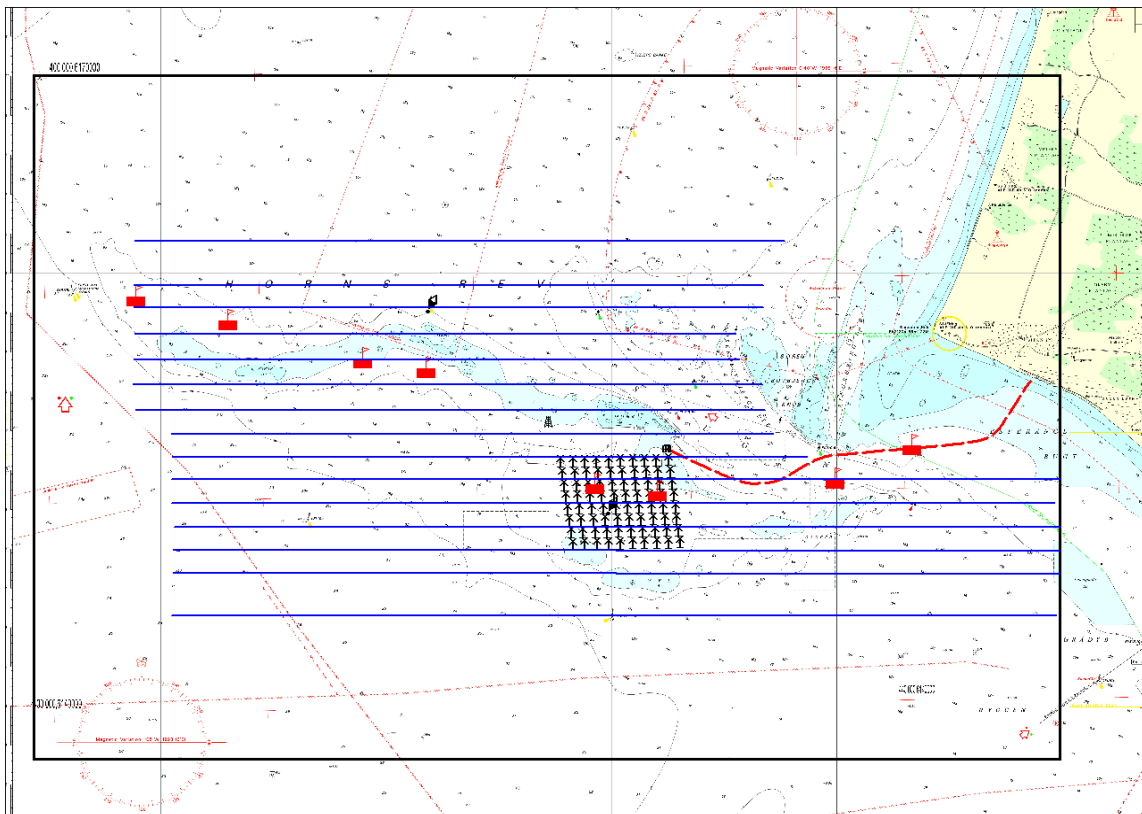

Fig. 3.9: Survey design, line transects indicated by blue lines.

As an experiment, acoustical surveys were carried out by towing a T-POD after the survey ship in a specially designed towing rig. Hydrographical data were collected simultaneously with records of porpoises.

For more details on the visual and acoustic surveys see the full report from Ornis Consult A/S⁸.

3.5.2 Results of Monitoring 2001

3.5.2.1 Patterns of Harbour Porpoise Activity

Daily Click Frequency and Intensity

While the variations in click intensity appeared unrelated to stations or T-PODs, there were large variations in the daily click frequency between stations and T-PODs. The variations were apparently associated with the wind-induced variation in the position of the frontal zone. T-POD 6 at the western edge of the reef recorded high frequencies of clicks during the anti-cyclonic weather in August, while the frequencies were at a medium level during moderate cyclonic weather in October and dropped to low levels following the passage of strong low pressure systems in November. The highest frequencies of clicks were observed over the central part of the reef (POD 3, Table 3.7) during two periods in August and October characterised by anti-cyclonic and moderate cyclonic weather. The frequencies at T-POD 3 dropped to low-medium levels in November-December. Medium frequencies were recorded in the impact area in the eastern part of the reef throughout the period, while low frequencies were observed in the eastern part of Slugen during the relatively calm period up to mid September (position 8, 2 T-PODs).

Area	Station	T-POD no.	Periods	Freq.	Intensity
Horns Rev	Pos. 1	37 (I)	39 days in 15/8-5/12	1.54 %	64.8
	Pos. 3	38 (I)	29 days in 15/8-18/1	5.22 %	69.8
	Pos. 5	53281(X)	49 days in 13/10-22/12	0.90 %	71.1
	Pos. 6	40 (I)	67 days in 10/7-21/12	0.99 %	68.4
	Pos. 8	32 (I)	26 days in 10/7-4/8	0.13 %	82.7
	Pos. 8	41 (I)	64 days in 10/7-11/9	0.18 %	75.2

Table 3.7: Average daily click frequency and intensity for T-PODs deployed in the investigation areas. The T-POD transducer type is listed in parentheses after T-POD no. (I = Internal, X = External).

⁸ Investigations of harbour porpoises at the planned site for wind turbines at Horns Rev. Status report 1/1 2001 – 1/4 2002. Technical report for Tech-wise A/S. Ornis Consult A/S, March 2002.

Activity Events

The results for the activity events were similar to the daily click frequency in that event duration was longer and waiting time shorter over the western part of the reef (POD 1) during July-October 2001 compared to the situation in November and December. The central part of the reef generally had the longest event and shortest waiting times (POD 3) during the periods characterised by continental climate. In the impact area (PODs 5 and 6) event duration and waiting times were stable at an intermediate level, while events of harbour porpoise activity were rare and short in the eastern part of Slugen (Pos. 8).

Area	Station	T-POD no.	Periods	Event duration	Waiting time
Horns Rev	Pos. 1	37 (I)	304 events in 15/8-5/12	5.15	162
	Pos. 3	38 (I)	354 events in 15/8-18/1	12.62	88
	Pos. 5	53281(X)	283 events in 13/10-22/12	3.74	230
	Pos. 6	40 (I)	408 events in 10/7-21/12	3.93	207
	Pos. 8	32 (I)	31 events in 10/7-4/8	2.16	1131
	Pos. 8	41 (I)	107 events in 10/7-11/9	2.19	846

Table 3.8: Mean event duration and time between events for T-PODs deployed at Horns Rev (unit = minutes). The T-POD transducer type is listed in parentheses after T-POD no. (I = Internal, X = External).

3.5.2.2 Harbour Porpoise Distribution

The first survey was undertaken during the period 15-18 August and the second survey during 21-22 August. Sea states above Beaufort 1 occurred several times during the first survey, which resulted in many breaks of the survey effort. The second survey ran according to schedule, as conditions here were excellent with flat sea prevailing.

Temporal and Spatial Variability

Although the two surveys were executed only three days apart, the distribution of harbour porpoise was markedly different during the two surveys. During the first survey, densities over 3 animals per km² were recorded in the intermediate salinity range (30-31 psu) over the eastern part of Horn Reef, including the wind farm area, and in Slugen. During the second survey, however, as the intermediate salinity range was advected westwards the high densities were confined to the central and western part of reef, with fewer sightings in the traditional high-density area.

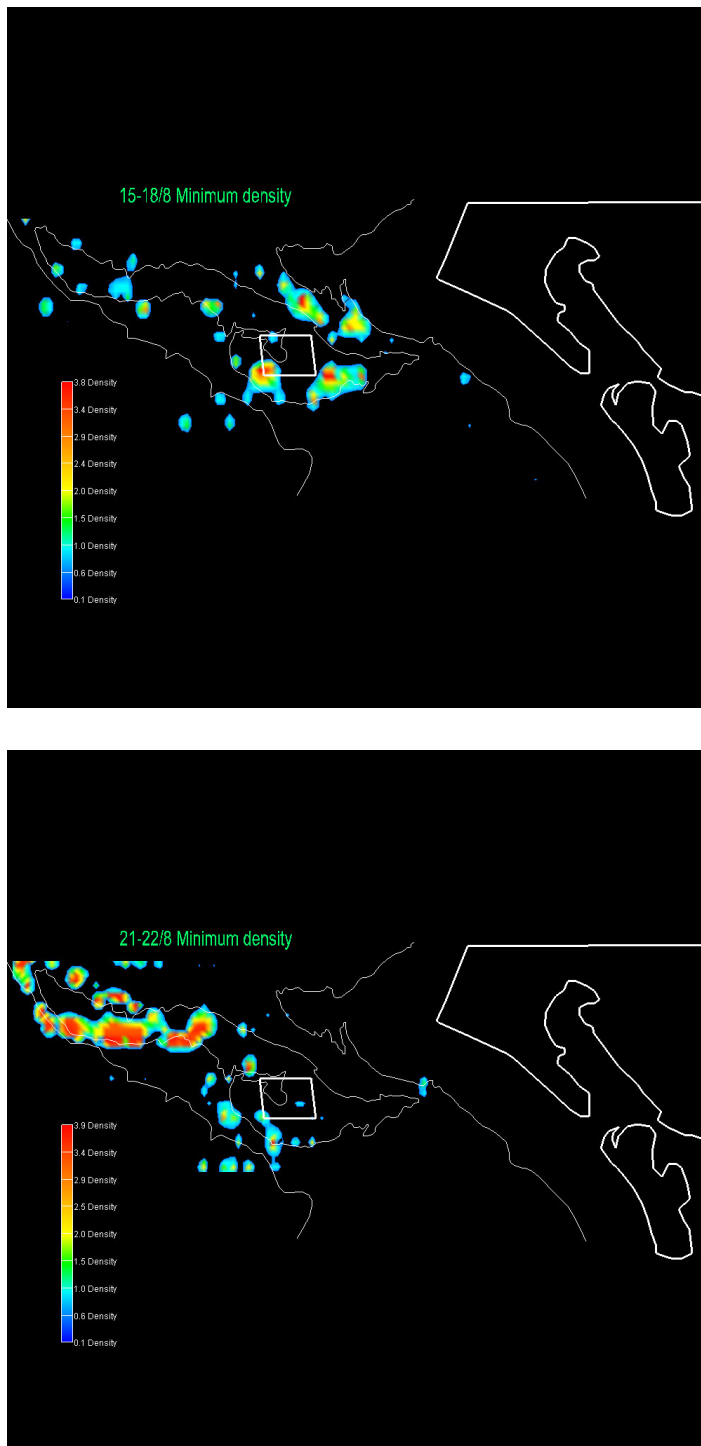

Fig. 3.10: Spatial models (kriging) of the distribution of harbour porpoise during the two surveys at Horns Rev. The minimum density distribution truncated at 0.5 animals per km² and based on a 90 % confidence level of the predicted densities is given.

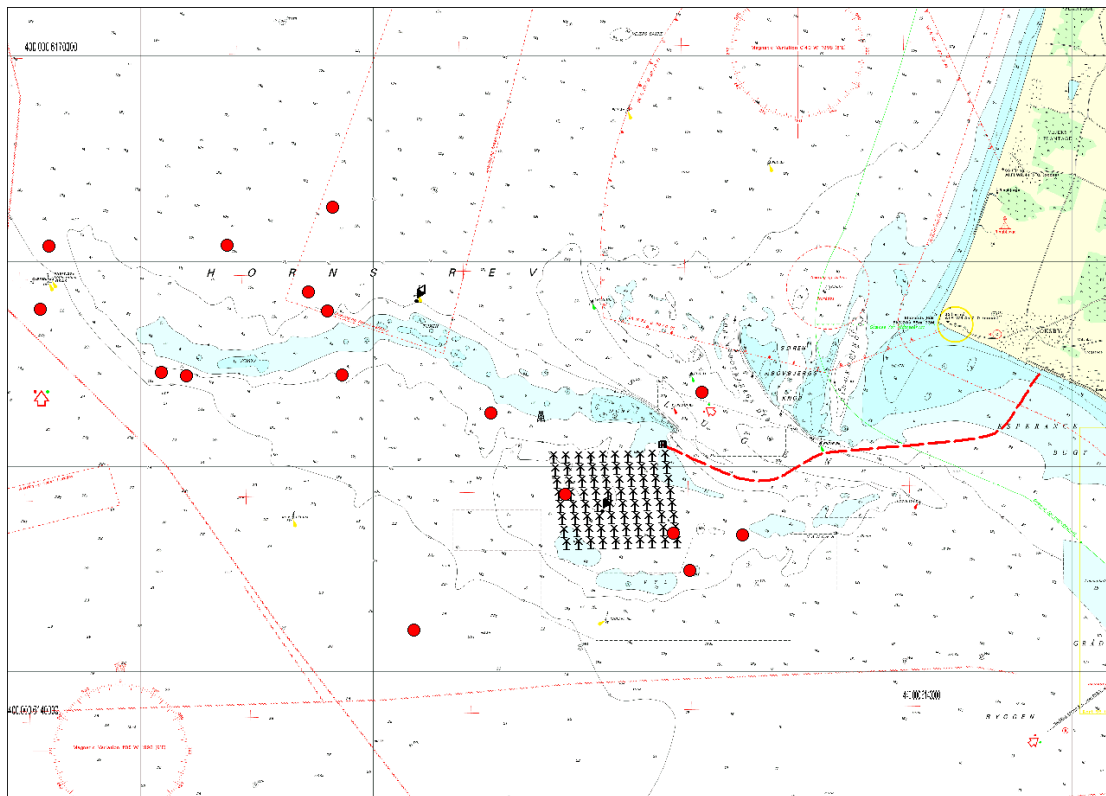

Fig. 3.11: Sightings of calves during the two surveys on Horns Rev.

During both surveys calves were observed throughout the area, including in the wind farm site.

3.5.3 Conclusions

The experiments with the application of towing the T-POD is now successfully implemented. The future surveys will show whether the acoustic survey data can assist the visual observations.

It seems, that the harbour porpoises follow the salinity range. With only few days between two surveys, densities over 3 animals per km² were recorded in the intermediate salinity range (30-31 psu) at the eastern part of Horns Rev, including the wind farm area, and in Slugen in the first survey. During the second survey, an intermediate salinity range was advected westwards and the high densities were confined to the central and western part of the reef.

In spite of practical problems related to the launch and operationalisation of the T-PODs the results of the acoustic monitoring have been encouraging. Among other things it has been documented that the acoustic data display similar variations in relation to hydrography as observed in the survey data.

4. Conclusions

In 2001 the environmental monitoring performed was all part of baseline descriptions for the Horns Rev area before constructing the wind farm.

The baseline investigation for the bottom flora and fauna has shown that there is no prior difference in benthos community structure related to the distance from the foundations. The study related to the stomach content of fish has shown that there is a significant difference in the benthic community structure "fingerprint" between the designated reference area and the wind farm area. The study indicates, however, that the reference area can be used for comparison of the stomach content of different fish species as the dominant benthos species are recorded from both areas. The studies have shown that there are no significant differences in community structure, although there is a significant higher abundance and biomass in the autumn and between the surveys in spring/summer and autumn.

All this shows that the monitoring programme for the bottom flora and fauna is designed in a way to make it possible to prove or reject the hypotheses about effects.

The monitoring programme for fish contained the testing of the newly developed KFG research gillnets under the extreme conditions at Horns Rev. The conclusion is that the KFG gillnets function well and that it is possible to complete the monitoring programme almost as proposed. However, the strong currents, exposed conditions and occurrence of huge numbers of crabs made it necessary to alter the original experimental field design to take these particular conditions into consideration. The preliminary results of the monitoring in 2001 show no significant differences between fish assemblages in the two areas, indicating the suitability of the reference area with this respect.

The bird programme has shown some year-to-year variation in the abundance and the distribution of the species in the Horns Rev area. Whether this variation represents a normal variation in the area is difficult to assess, as the study period only comprises two and a half years. A variation in the within-year abundance and distribution has been found, but this correlate to the phenology of the same species at Blåvandshuk. In general, it can be concluded that the data so far indicate that the wind farm area is not of any particular importance to the birds exploiting the area. If the birds avoid exploiting the wind farm area, the impact is estimated to affect less than 1 % of the different species except divers where 1.58 % may be affected.

No conclusions for 2001 can be made in relation to seals as the monitoring only started in 2002.

The surveys of the harbour porpoises shows varying distribution patterns, but the trend is that the central and eastern parts of Horns Rev are characterised by a stable, relatively high abundance, the western reef by more variable abundance and the eastern part of Slugen by low abundance. The scale of these different 'compartments' of Horns Rev is

less than 15 km, which means that the click data seem to be able to indicate distribution levels within rather discrete areas. The T-POD data indicate a higher level of activity at the central part of the reef as compared to the wind farm area. This difference is not apparent in the average density distributions retrieved from surveys.

The stable activity over the central and eastern part of the reef can be linked to the mean position of the frontal zone, while the variable activity over the western part of the reef can be linked to the more irregular occurrence of the frontal zone in this part of the reef.

The results obtained have increased the confidence in successfully applying a monitoring programme for harbour porpoises based on combined hydrographic and acoustic stations and survey data.

5. Programme for the Environmental Surveys in the Area in 2002

The below evaluations of the environmental surveys are based on experiences from each monitoring programme as well as the results of the total 2001 monitoring programme for Horns Rev and Rødsand.

5.1 Bottom Flora and Fauna

According to the environmental impact assessment no measurable changes are expected in the bottom flora and fauna after construction of the wind farm. In order to make a basic description of the area, a sampling programme for the benthic fauna has been carried out during 2000-2001.

The baseline study should provide sufficient data to evaluate the effects on the composition of species and individuals of the benthic fauna as a result of the establishment of foundations, in both the construction and operational phases.

On this background, the baseline description of the benthic fauna (infauna) of the area is carried out as the basis for comparison with a subsequent control and monitoring programme, which is to be started in 2002. During the autumn of 2002 a sampling programme on foundations and scour protection will be initiated to follow a new epifauna on the foundations including scour protection. The results will be included in the below fish programme to evaluate the food sources for the fish species in the wind farm area.

5.2 Fish

The EIA survey showed that there is a large deviation over the year in the spread of fish species and their amount. In general, it is not expected to find differences in the spread of fish before and after construction of the wind farm.

As mentioned previously, the introduction of new habitats is expected to result in an area with a larger food basis for fish. Fish are expected to be attracted to this area, especially around the foundations and the scour protection.

On this basis it has been decided to follow this development through a fish programme, where - during 2001 and the first six month of 2002 - a baseline study of the occurrence of fish will be prepared.

In the last six month of 2002, after construction of the wind farm, the same sampling programme will be accomplished to follow the development of the fish fauna around the foundations of the wind farm.

The sand eel is living buried in sediment of a certain composition. It is very easily influenced by even small changes to the sediment composition and the chances of the sand eel spawn surviving the winter are easily affected. Due to the high yearly variation of the sand eels, the wind farm area is expected to have only minor impacts on population of this fish species. As the sand eel can be used as a parameter for sediment changes, it has been decided to look at sand eels in the wind farm area as this would likely reveal small changes to the sediment composition after erection of the wind farm. In the beginning of 2002 a sampling programme was carried out to investigate the sand eel's use of the wind farm area for living and settling.

5.3 Seals

It was decided to implement a baseline study of the seals' use of the wind farm. A total of ten seals will be marked in 2002 with transmitters to be able to follow their travel pattern. The survey is accomplished during the first six months of 2002 to cover the period before commissioning as well as the construction phase.

It is not expected to make any surveys or to mark any seals after construction of the wind farm.

5.4 Harbour Porpoises

On the basis of two years of ship-based surveys and analyses of historic data, the impact assessment regarding harbour porpoises for the Horns Rev wind farm was finalised in February 2000. A conclusion was that based on the high availability of data it would be possible to make impact studies of the harbour porpoises: The suggestion was to evaluate e.g. short-term effects on harbour porpoises as a result of disturbance during the construction phase caused by a large number of service boats and sound emissions from the ramming activities. Moreover, it was suggested to evaluate if the animals would return to the area after the construction activities have ceased.

Salinity measurements have been accomplished in the area, which have confirmed our expectations of a connection between the salinity and the occurrence of harbour porpoises in the Horns Rev area. Furthermore, Horns Rev is considered an area with a high occurrence of harbour porpoises and this fact makes it interesting to carry out effect studies in the area.

5.5 Birds

So far, there is no indication of any important impact of the wind farm on any bird species recorded in the Horns Rev area.

An extensive survey of the birds by means of aerial surveys will be continued during the spring 2002 to extend the baseline study of the spread of birds in the area. The surveys

will be intensified during the last six months of 2002 by means of aerial surveys and by carrying out observations from area to register possible impacts.

6. References

1. Havmøller Horns Rev. Vurdering af virkninger på miljøet. VVM-redegørelse. Maj 2000, Elsamprojekt 2000. (Horns Rev Offshore Wind Farm. Environmental Impacts Assessment. EIA Report).
2. Horns Rev. Control and monitoring programme. Artificial reef. Progress memorandum 2. Bioconsult 21. January 2002.
3. Investigations of harbour porpoises at the planned site for wind turbines at Horns Rev. Status report 1/1 2001 – 1/4 2002. Technical report for Tech-wise A/S. Ornis Consult A/S, March 2002.
4. Status report of seabird surveys at Horns Rev, 2000 – 2001. NERI report 2002.
5. Havmøller Horns Rev. Vurdering af virkninger på miljøet. VVM-redegørelse. Maj 2000, Elsamprojekt 2000. (Horns Rev Offshore Wind Farm. Environmental Impacts Assessment. EIA Report).
6. Effects on birds of an offshore wind farm at Horns Rev: Environmental impact assessment. NERI report 2000.
7. Environmental impact assessment. Investigation of marine mammals in relation to the establishment of a marine wind farm at Horns Rev. Fisheries and Maritime Museum, Esbjerg, Ornis Consult A/S and Zoological Museum, University of Copenhagen, 2000.
8. Havmøller Horns Rev. Vurdering af virkninger på miljøet. VVM-redegørelse. Maj 2000, Elsamprojekt 2000. (Horns Rev Offshore Wind Farm. Environmental Impacts Assessment. EIA Report).
9. Investigations of harbour porpoises at the planned site for wind turbines at Horns Rev. Status report 1/1 2001 – 1/4 2002. Technical report for Tech-wise A/S. Ornis Consult A/S, March 2002.
10. Investigations of harbour porpoises at the planned site for wind turbines at Horns Rev. Status report 1/1 2001 – 1/4 2002. Technical report for Tech-wise A/S. Ornis Consult A/S, March 2002.